

MATERIAL: SEE B/M
 DRAWN: TFK
 CHECKED: DEP
 SCALE: NONE
 DATE: 9-15-95

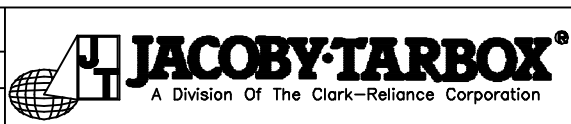

SIGHT FLOW INDICATOR
 608-SJA, 910-SJA
 (STEAM JACKET)

Section: T400
 Bulletin: T400.09
 Date: 12/01/00
 Supersedes: 11/10/98

150 ASME CLASS MODELS

FILE NO.: T400-09.DWG

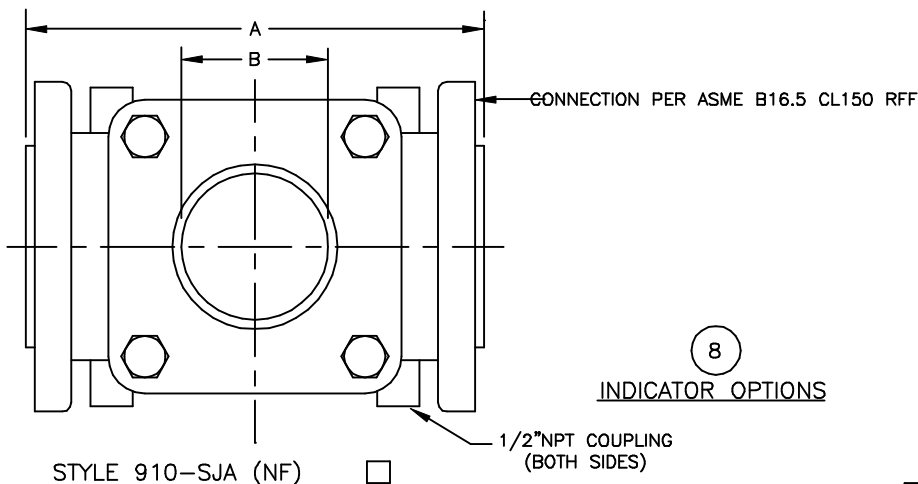

8
 INDICATOR OPTIONS

STYLE 910-SJA (NF)

1/2"NPT COUPLING
 (BOTH SIDES)

OPTIONS

DUAL UNIGLAS
 WINDOWS

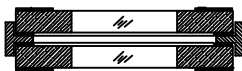

FULL VIEW DUAL
 WINDOWS

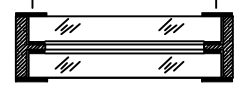

UNIGLAS WINDOW

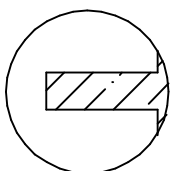
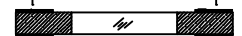

PTFE FLUTTER
 STYLE 910-SJA-FLTR

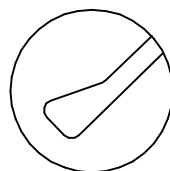

FLAPPER
 STYLE 910-SJA

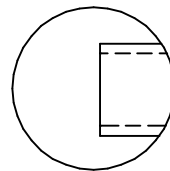

DRIP TUBE
 STYLE 608-SJA

PARTS LIST

PIECE NO.	NAME OF PART	QUAN.	MATERIAL	COMMENTS
1	BODY	1	SEE BELOW	
2	RETAINER	2	STEEL	
3	CUSHION	2	FIBER	
4	SEAL GASKET	2		
5	WINDOW	2	BOROSILICATE	
6	BOLT		STEEL	
7	NUT		STEEL	
8	INDICATOR	1		

THIS DRAWING AND ALL INFORMATION ON IT IS THE PROPERTY OF JACOBY-TARBOX, DIVISION OF THE CLARK-RELIANCE CORPORATION. IT IS CONFIDENTIAL AND IS GIVEN TO YOU FOR A LIMITED PURPOSE AND MUST BE RETURNED UPON REQUEST. NEITHER THIS DRAWING NOR ANY PART OF IT NOR ANY INFORMATION CONCERNING IT MAY BE COPIED, EXHIBITED OR FURNISHED TO OTHERS NOR MAY PHOTOGRAPHS BE TAKEN OF ANY ARTICLE FABRICATED OR ASSEMBLED FROM THIS DRAWING WITHOUT CONSENT OF THE CLARK-RELIANCE CORPORATION.

ASME CLASS P/T RATINGS

TEMP F	150 CLASS	
	STEEL	316 SS
-20 TO 100	285	275
150	270	260
200	260	240
250	245	230
300	230	215
350	215	205
400	200	195
450	185	180
500	170	170

STANDARD DESIGN MATERIALS:

BODY: ASTM A216-WCB (CARBON STEEL)
 ASTM A351-CF8M (316 SS)

RETAINER: ASTM A516 GR. 70 (STEEL)
 FASTENERS: A354-BD/A194-2H (STEEL)
 INDICATOR: 316 SS FLAP&DRIP , PTFE FLUTTER
 OPTIONAL ALLOYS FURNISHED UPON REQUEST

DIMENSIONS

PIPE SIZE	A		B		C		APPROX. WGT.		# STUDS
	IN.	mm	IN.	mm	IN.	mm	LBS.	KGS.	
1/2&3/4	4-5/8	118	1-1/4	32	3-11/16	94	6	2.7	4
1 X 1	5-5/8	143	1-1/4	32	4-1/4	108	8	3.6	4
1.5 X 1.5	6-1/2	165	2	51	5-3/4	146	15	6.8	4
2 X 2	7-7/8	200	2	51	6-3/8	162	22	10	4
2 X 3	8.250	209	2	51	6-3/8	162	22	10	4
3 X 3	9-3/8	238	3-3/16	81	7-15/16	202	44	20	4
3 X 4	9-3/8	238	3-3/16	81	7-15/16	202	44	20	4
4 X 4	11	279	4-3/8	111	9-1/2	241	67	30.4	4
6 X 6	14-1/4	362	6	152	12-11/16	322	120	54.4	4
8 X 8	16-1/8	410	8-1/4	210	15-11/16	399	230	104.3	4
10	24-3/4	629	11	279	21-11/16	551	405	183.7	16
12	25-3/4	654	11	279	21-11/16	551	460	208.7	16
14	26-3/4	679	11	279	25	635	505	229	16
16	26-3/4	679	11	279	25	635	555	251.7	16