



Series V4

FLOTECT® Vane Operated Flow Switch

Field Adjustable — Dependable Protection Against Flow Variation or Stopping in Pipelines for Fluids, Gases and Flowing Solids



Flow

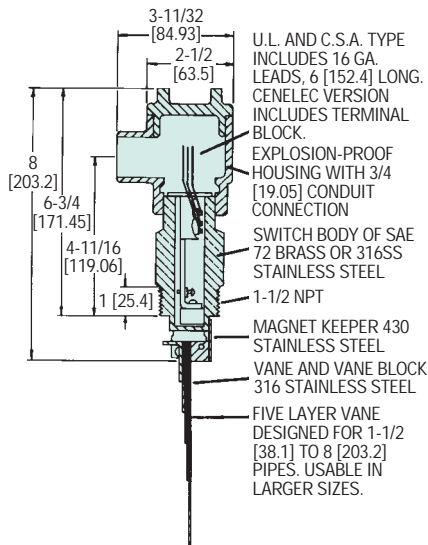

Rugged and reliable the Series V4 Flotect® flow switch operates automatically to protect equipment and pipeline systems against damage from reduction or loss of flow. The V4 is time tested being installed in thousands of pipelines and processing plants around the world. A unique magnetically actuated switching design gives superior performance. There are no bellows, springs, or seals to fail. Instead, a free-swinging vane attracts a magnet within the solid metal switch body, actuating a snap switch by means of a simple lever arm.

FEATURES

- Leak proof body machined from bar stock
- Choice of custom vane calibrated for your application, Model V4, or field adjustable multilayer vane, Model V4-2-U (see set point chart)
- Weatherproof, designed to meet NEMA 4
- Explosion-proof (listing included in specifications)
- Installs directly and easily into pipeline with a thredolet, tee, or flange (see application drawings)
- Can be used in pipes 1-1/2" and up
- Electrical assembly can be easily replaced without removing the unit from installation so that the process does not have to be shut down
- High pressure rating of 1000 psig (69 bar) with the brass body and 2000 psig (138 bar) with the 316 SS body

APPLICATIONS

- Protects pumps, motors and other equipment against low or no flow
- Controls sequential operation of pumps
- Automatically starts auxiliary pumps and engines
- Stops liquid cooled engines, machines and processing when coolant flow is interrupted
- Shuts down burner when air flow through heating coil fails
- Controls dampers according to flow

SPECIFICATIONS

Service: Gases or liquids compatible with wetted materials.

Wetted Materials:

Vane: 316 SS.

Body: Brass or 316 SS standard.

Magnet Keeper: 430 SS standard, 316 SS optional.

Options: Other materials also available, consult factory (e.g. PVC, Hastelloy, Nickel, Monel, Titanium).

Temperature Limit: -4 to 275°F (-20 to 135°C) standard, MT high temperature option 400°F (205°C) [MT option not UL, CSA, ATEX, or SAA].

Pressure Limit: Brass body 1000 psig (69 bar), 316 SS body 2000 psig (138 bar), optional 5000 psig (345 bar) available with 316 SS body and SPDT switch only.

Enclosure Rating: Weatherproof and Explosion-proof. Listed with UL and CSA for Class I, Groups C and D; Class II, Groups E, F, and G.

ATEX **CE** 0344 **Ex** II 2 G EEx d IIB T6 -20°C ≤ Tamb ≤ 75°C

EC-Type Certificate No.: KEMA 03ATEX 2383

SAA: Exd II C T6 (T amb=60°C). Zone I. Also FM approved.

Switch Type: SPDT snap switch standard, DPDT snap switch optional.

Electrical Rating: UL, FM, ATEX and SAA models 10A @ 125/250 VAC (V-). CSA models: 5A @ 125/250 VAC (V-); 5A res., 3A ind. @ 30 VDC (V-). MV option: 1A @ 125 VAC (V-); 1A res., .5A ind. @ 30 VDC (V-). MT option: 5A @ 125/250 VAC (V-). [MT and MV option not UL, CSA, FM, ATEX or SAA].

Electrical Connections: UL and CSA models: 16 AWG, 6" (152 mm) long. ATEX and SAA unit: Terminal block.

Conduit Connection: 3/4" female NPT.

Process Connection: 1-1/2" male NPT.

Mounting Orientation: Within 5° of vertical for proper operation. Units for horizontal installation (vertical pipe with up flow) available.

Set Point Adjustment: For universal vane: five vane combinations.

Weight: 4 lb 8 oz (1.9 kg).

Agency Approvals: UL, CSA, CE, FM, SAA, and ATEX.

MODELS

| Model | Description |
|-----------|-----------------------------|
| V4-2-U | Brass body, universal vane |
| V4-SS-2-U | 316SS* body, universal vane |
| V4 | Brass body, custom vane |
| V4-SS | 316SS* body, custom vane |

*316SS body with 430SS magnet keeper. For 316SS magnet keeper, specify: add -316

Options (add as a suffix to the model number):

-D, DPDT contacts

-MV, Gold Plated Contacts, options for dry circuits

(see electrical rating in specification, no listings or approvals)

-MT, High Temperature, option rated 400° F (204° C)

(see electrical rating in specifications, no listings or approvals)

-TRI (increasing flow), -TRD (decreasing flow), Time Delay Relay,

option with 2 SPDT contacts, adjustable from 0-1 to 0-31 minutes.

(no listings or approvals)

-316, 316 SS Magnet Keeper, option to replace standard 430 SS

-SAA, SAA listed construction

-V, Vertical Up Flow, option for upward flow in vertical pipe

-AT, ATEX listed construction

Consult factory for price and availability of fittings for V4 installation. Thredolets, bushings, and tees are available in a variety of sizes and materials.

For custom vane models, please supply factory with following information: pipe size, flow direction (horizontal, up), mounting, pressure, temperature, specific gravity, flow rates (maximum normal, actuation/deactuation*), etc.

*When both values are supplied, note which is critical.

V4 Universal Vane Flow Charts

Values shown in both charts are nominal. If normal flows exceed actuation rates by less than 10%, custom vanes are recommended. Figures are based on standard vertical installation in a 1-1/2" thredolet in a horizontal run of pipe.

| APPROXIMATE ACTUATION/DEACTUATION FLOW RATES FOR COLD WATER. UPPER FIGURES IN GPM. LOWER FIGURES IN LPM | | | | | | | | | | | | |
|--|--------------------|-----------------|--------------------|-------------------|--------------------|---------------------|----------------------|----------------------|-----------------------|-----------------------|------------------------|------------------------|
| VANE LAYERS | 1.5"PIPE | 2"PIPE | 3"PIPE | 4"PIPE | 6"PIPE | 8"PIPE | 10"PIPE | 12"PIPE | 14"PIPE | 16"PIPE | 18"PIPE | 20"PIPE |
| 1 | 7-3 26.67-11.67 | 15-8 56.7-30 | 45-22 167-83.3 | 95-40 367-150 | 210-120 800-450 | 375-175 1417-667 | 600-300 2267-1133 | 900-450 3400-1700 | 1200-600 4550-2267 | 1400-800 5300-3033 | 2000-1000 7567-3783 | 2400-1200 9083-4550 |
| 1&2 | | 7-4 26.7-15 | 23-14 86.7-53.3 | 50-35 190-132 | 130-90 500-333 | 230-150 867-567 | 450-250 1700-950 | 650-350 2467-1317 | 900-500 3400-1900 | 1200-650 4550-2467 | 1450-800 5483-3033 | 1800-1000 6817-3783 |
| 1,2,&3 | | | 11-7 41.7-26.7 | 27-19 102-71.7 | 80-60 300-233 | 160-115 600-433 | 300-180 1133-683 | 450-275 1700-1033 | 600-350 2267-1317 | 750-450 2750-2083 | 1000-600 3783-2267 | 1200-700 4550-2650 |
| 1,2,3,&4 | | | | 17-12 65-45 | 60-45 233-167 | 120-90 450-333 | 230-150 867-567 | 310-200 1167-750 | 430-280 1633-1067 | 550-360 2083-1367 | 700-450 2650-1700 | 850-550 3217-2083 |
| 1,2,3,4,&5 | | | | | 40-30 152-113 | 80-65 300-250 | 135-100 517-383 | 200-140 750-533 | 290-200 1100-750 | 360-250 1367-950 | 460-325 1733-1233 | 575-400 2183-1517 |

Actuation rates are based on cold water at a specific gravity of 1.0. For fluids of different specific gravity, actuation rates may be approximated by dividing the rate shown by the square root of the specific gravity.

| APPROXIMATE ACTUATION/DEACTUATION FLOW RATES FOR AIR. UPPER FIGURES IN SCFM. LOWER FIGURES IN LPS | | | | | | | | | | | | |
|--|---------------|----------------|-------------------|-------------------|--------------------|---------------------|-----------------------|-----------------------|------------------------|------------------------|------------------------|-------------------------|
| VANE LAYERS | 1.5"PIPE | 2"PIPE | 3"PIPE | 4"PIPE | 6"PIPE | 8"PIPE | 10"PIPE | 12"PIPE | 14"PIPE | 16"PIPE | 18"PIPE | 20"PIPE |
| 1 | 32-17 15-8 | 65-32 30-20 | 210-105 100-50 | 400-200 190-90 | 950-475 450-220 | 1550-850 730-400 | 2400-1300 1100-600 | 3450-1900 1600-900 | 4700-2600 2200-1200 | 6400-3500 3000-1700 | 8000-4400 3800-2100 | 10000-5500 4700-2600 |
| 1&2 | | 23-13 10-6 | 120-70 60-30 | 195-140 90-70 | 550-375 260-180 | 1100-700 520-330 | 1850-1200 870-570 | 2700-1750 1300-800 | 3400-2200 1600-1000 | 4800-3100 2300-1500 | 6000-3900 2800-1800 | 7400-4800 3500-2300 |
| 1,2,&3 | | | 60-48 30-20 | 135-100 60-50 | 375-265 180-130 | 725-500 340-240 | 1200-850 570-400 | 1850-1300 870-610 | 2600-1800 1200-800 | 3350-2350 1600-1100 | 4300-3000 2000-1400 | 5300-3700 2500-1700 |
| 1,2,3,&4 | | | | 65-50 30-20 | 260-200 120-90 | 500-400 240-190 | 875-700 410-330 | 1250-1000 590-470 | 1900-1500 900-710 | 2500-2000 1200-900 | 3100-2500 1500-1200 | 3900-3100 1800-1500 |
| 1,2,3,4,&5 | | | | | 130-100 60-50 | 310-250 150-120 | 650-525 310-250 | 1000-800 470-380 | 1600-1250 760-590 | 2200-1750 1040-830 | 2800-2250 1300-1100 | 3550-2850 1700-1300 |

Actuation rates are based on air at standard conditions. For gases at other pressures, temperatures, or specific gravities, consult factory for equivalent flow approximations.

APPLICATION DRAWINGS FOR FLOTECT® AUTOMATIC FLOW SWITCHES

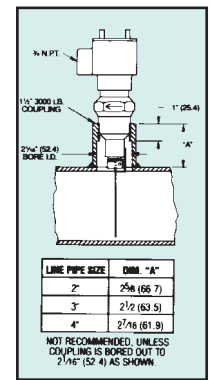
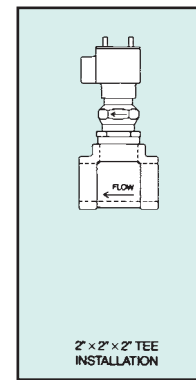
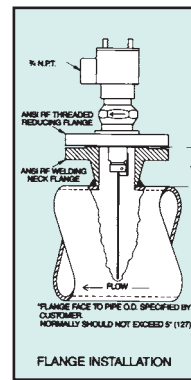
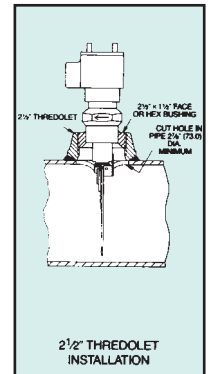
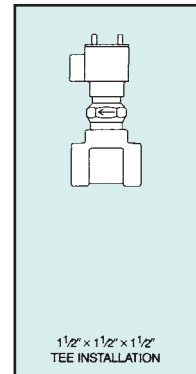
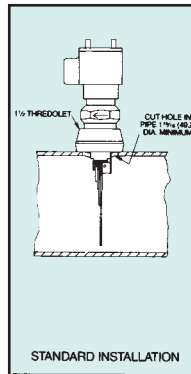
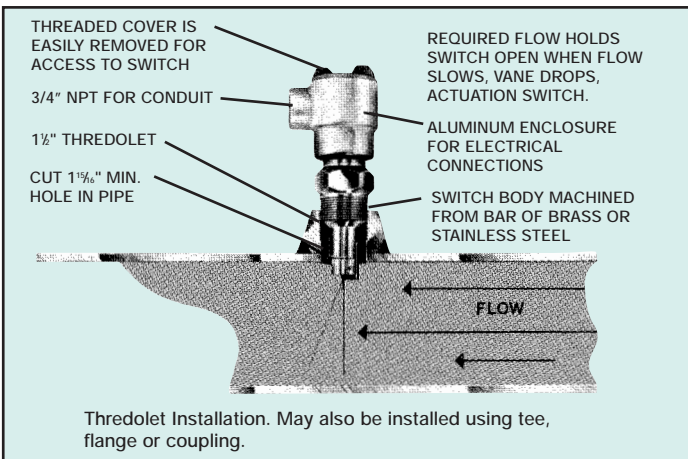

FLOW